

FLEUR LINE
ASSEMBLY MANUAL

MONTÁŽNÍ NÁVOD

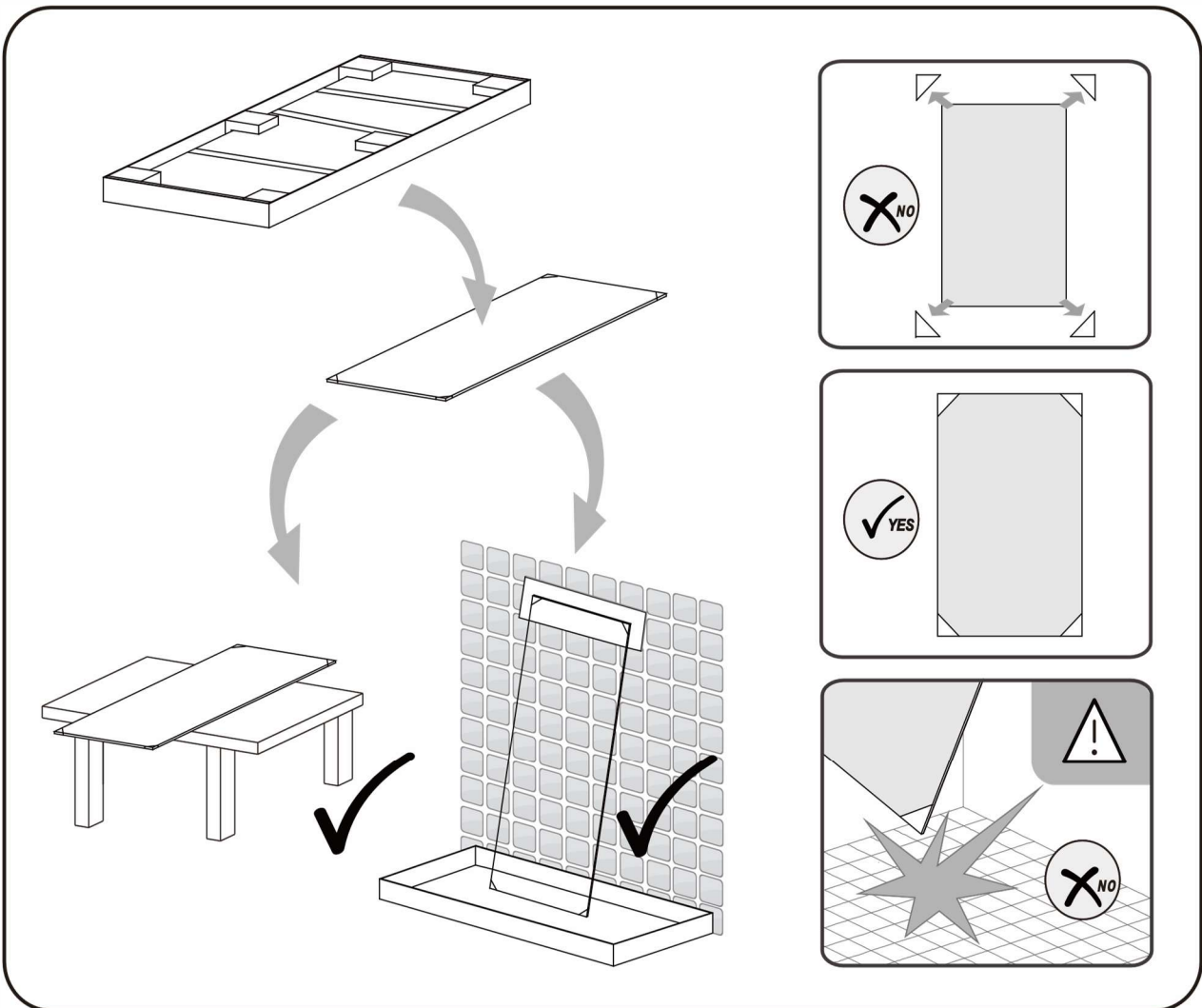

CAUTIONS

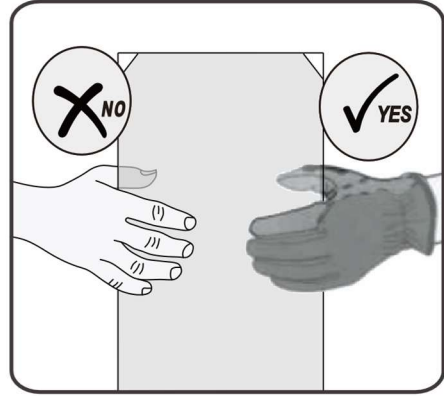
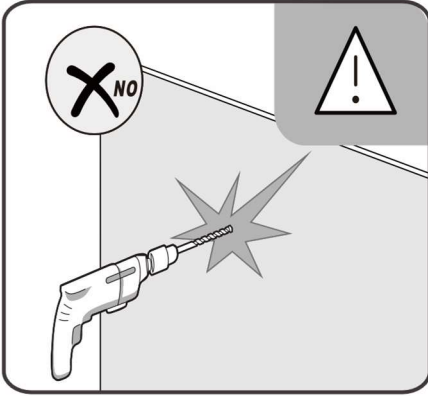

TOOLS REQUIRED



PENCIL



($\varnothing 6 \varnothing 3.2$)
DRILL BIT



SILICONE & GUN

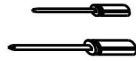

FLAT HEAD & CROSS
HEAD SCREWDRIVER



TAPE MEASURE



SPIRIT LEVE

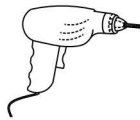



DRILL



RUBBER HAMMER

PACKING LIST

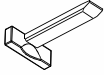
<p>B-702</p>	<p>B-823</p>	<p>C-022</p>	<p>D-068</p>	<p>D-069</p>
<p>I-1084</p>	<p>C-330</p>	<p>I-974</p>	<p>ST4*40</p>	<p>I-432</p>
<p>C-335</p>	<p>C-335</p>	<p>E-029</p>	<p>C-349</p>	<p>I-958</p>

<p>I-948</p> 	<p>I-942</p> 			
--	--	--	--	--

PRODUCT SCHEMATIC DIAGRAM

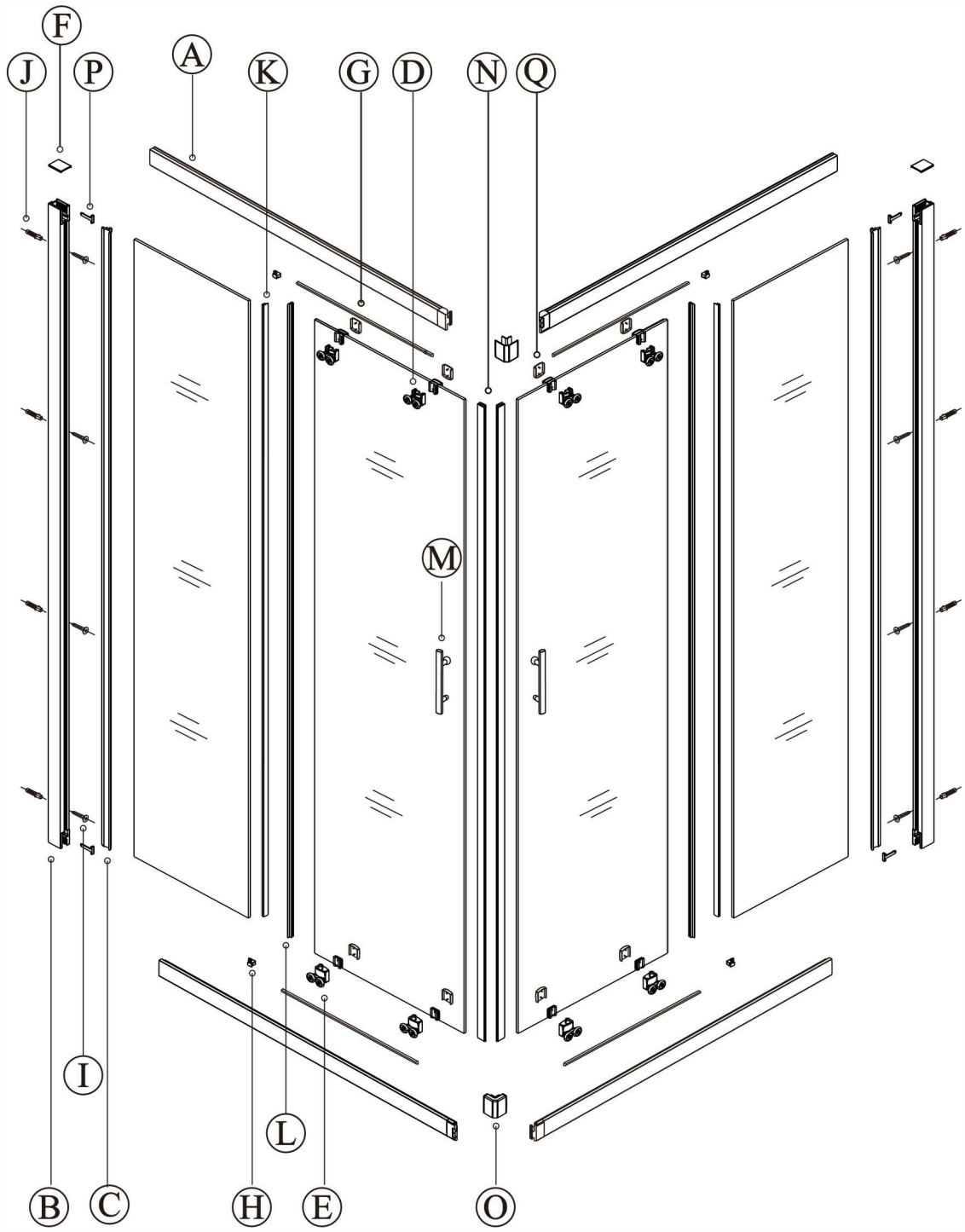

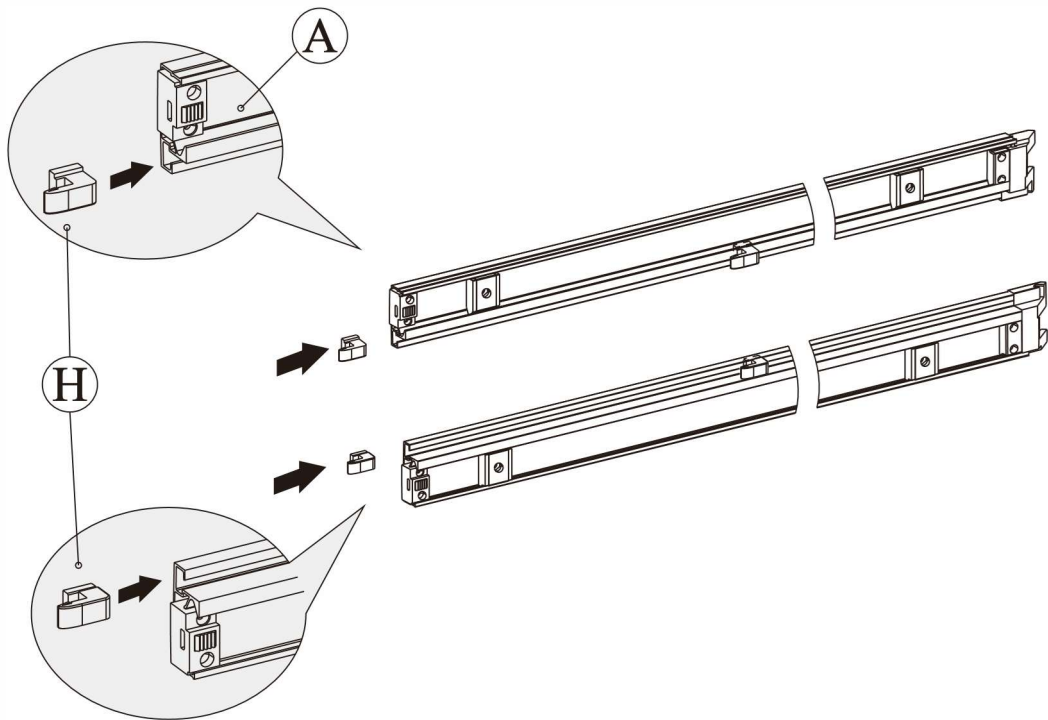

2

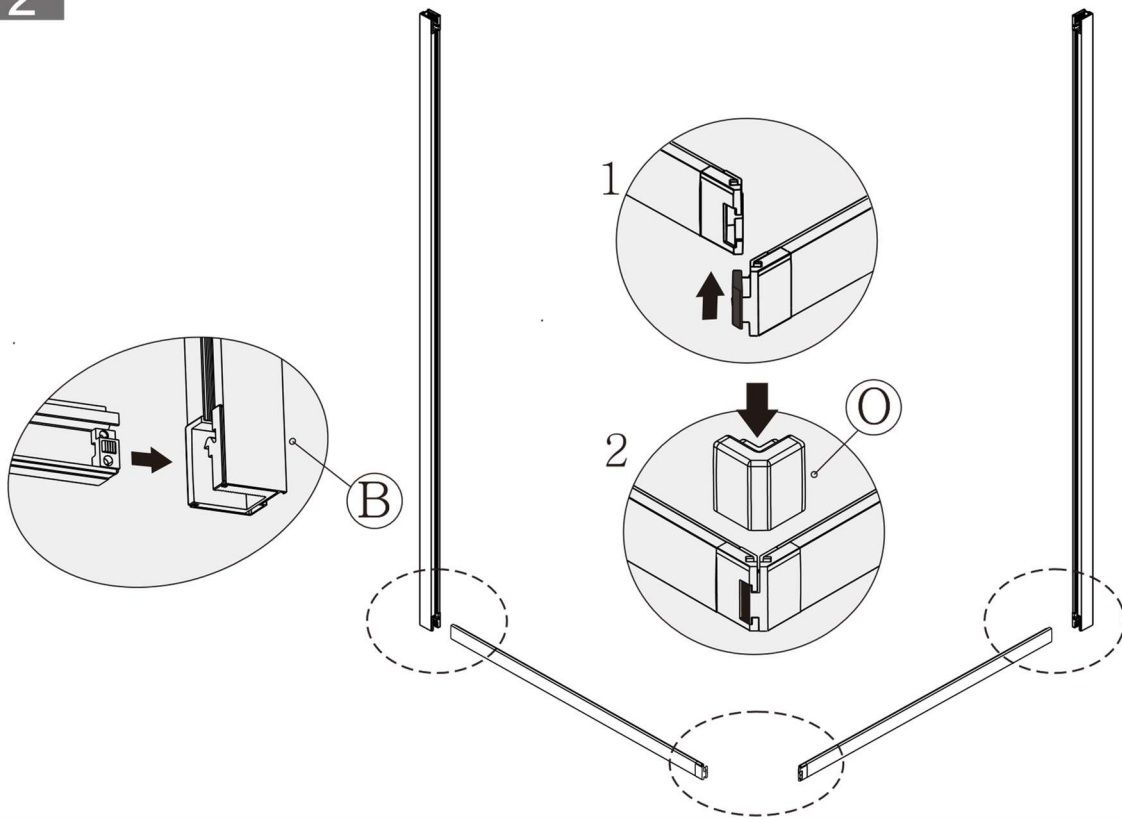

)

3

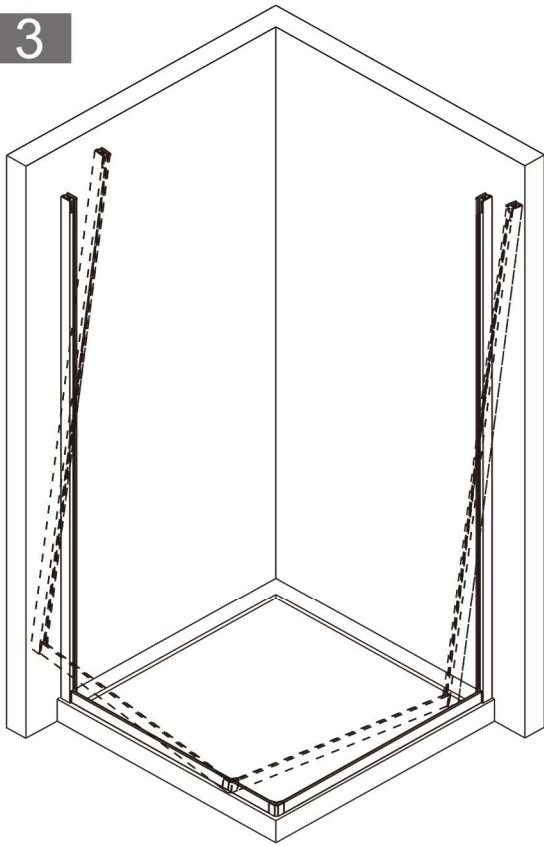

5

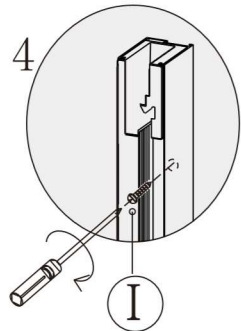
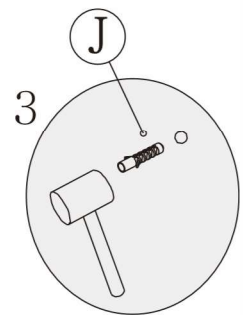
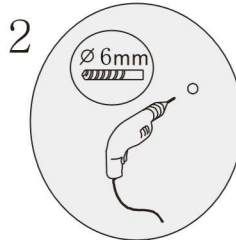
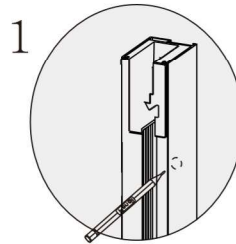
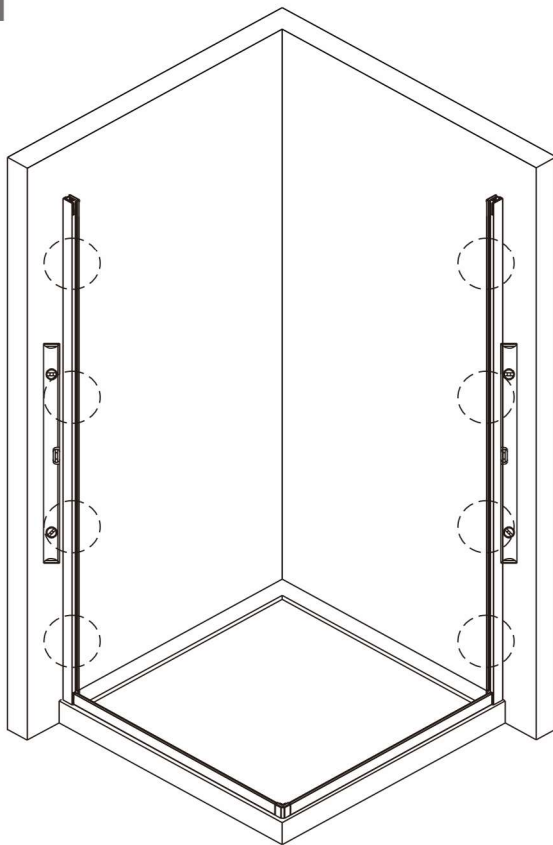

4

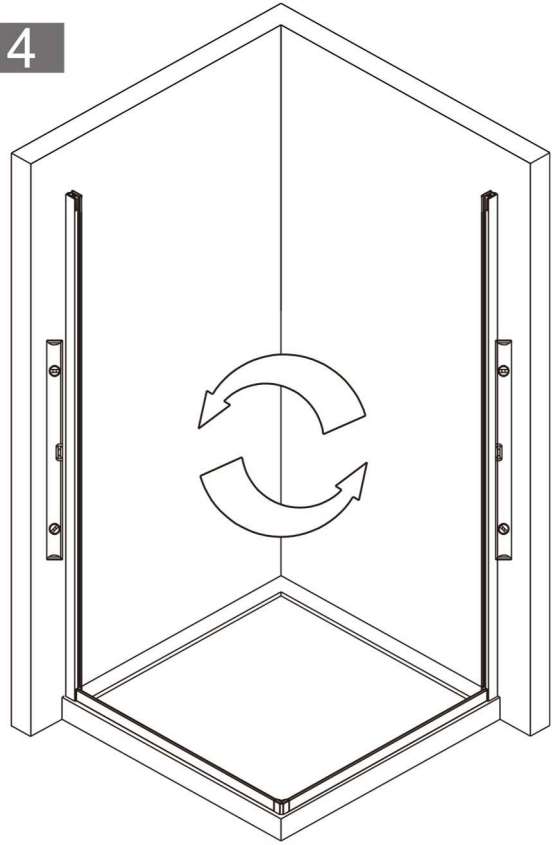

6

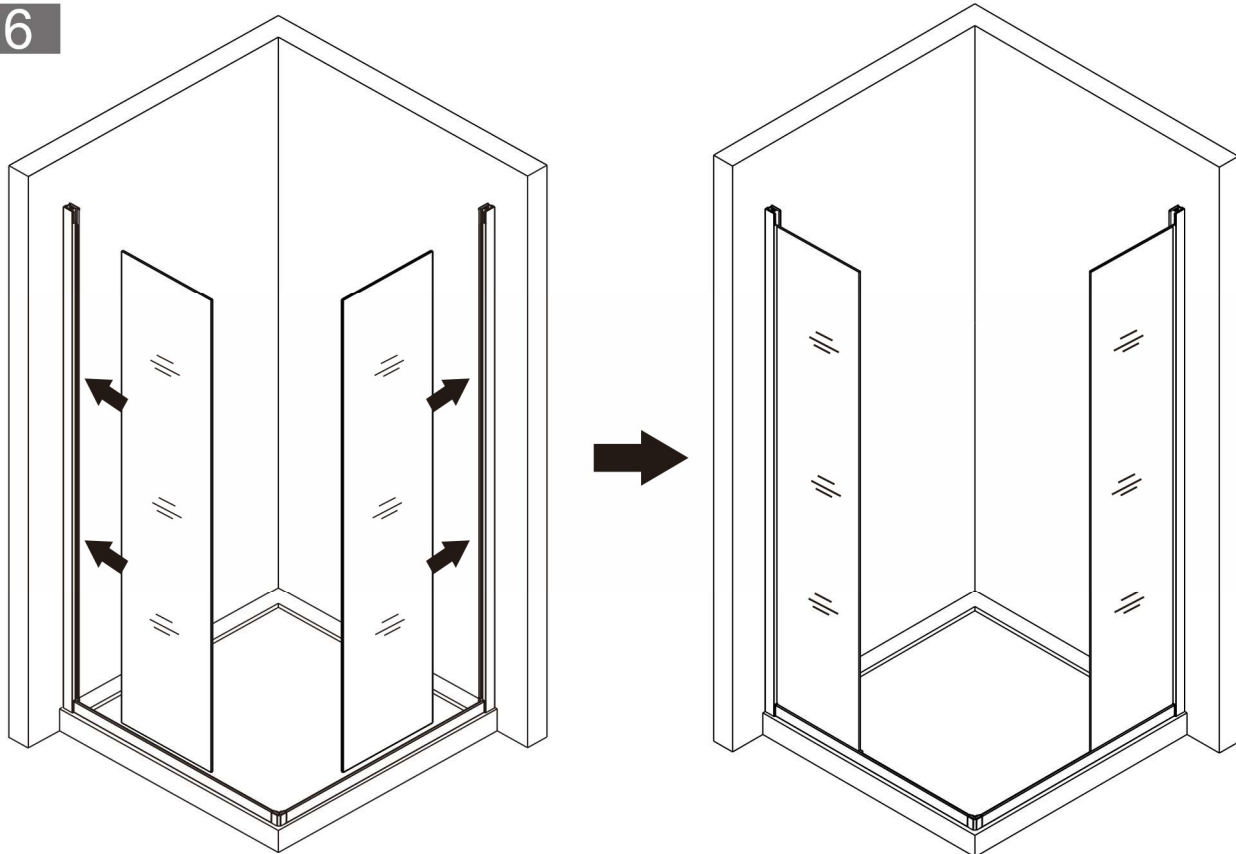

7

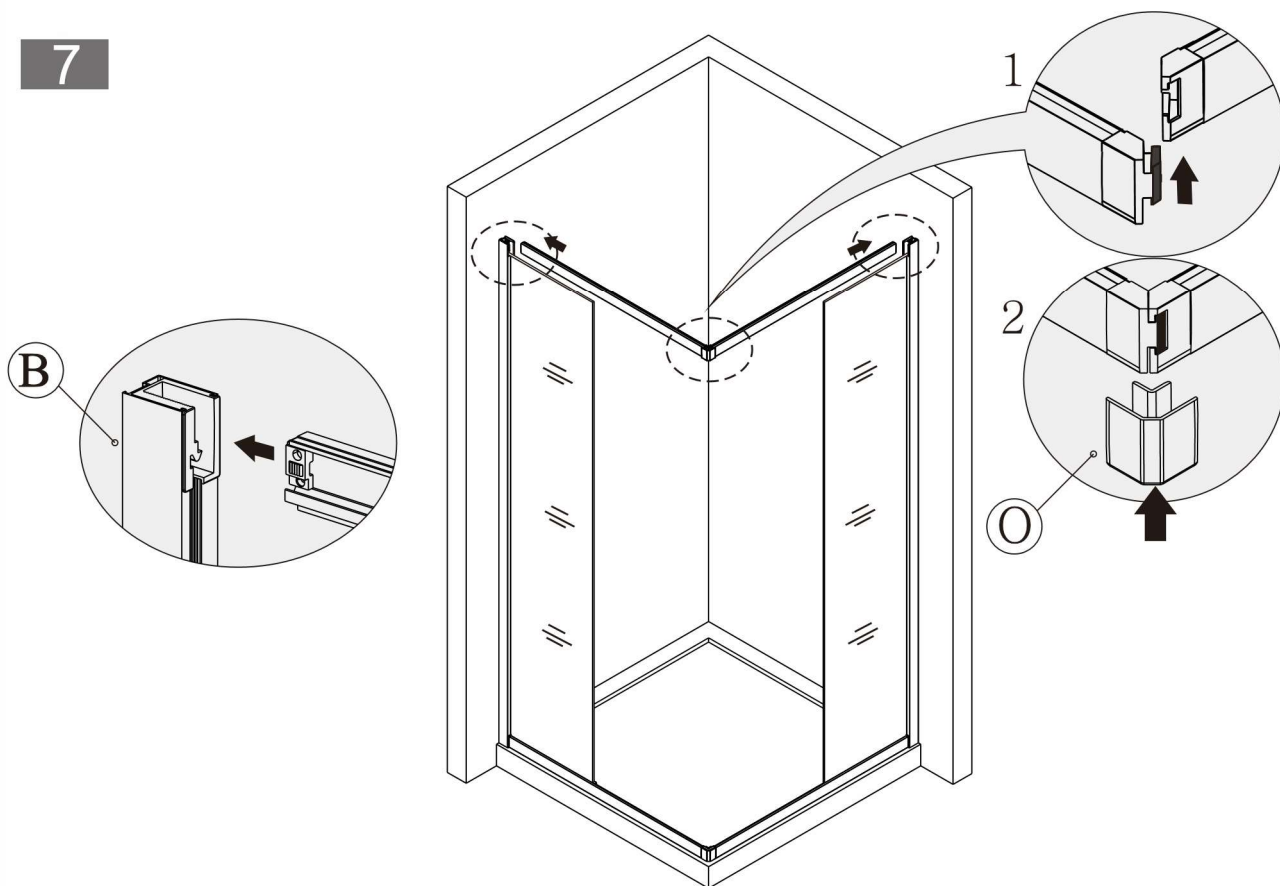

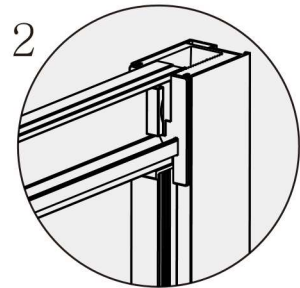
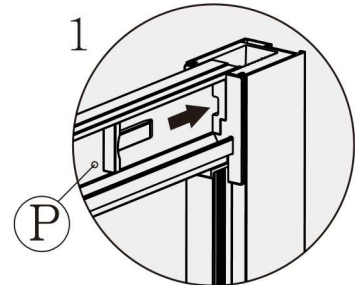
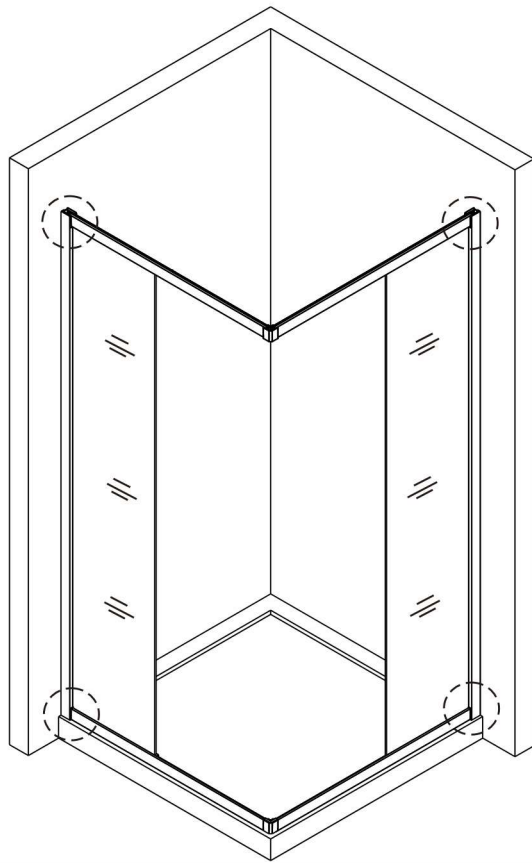

*

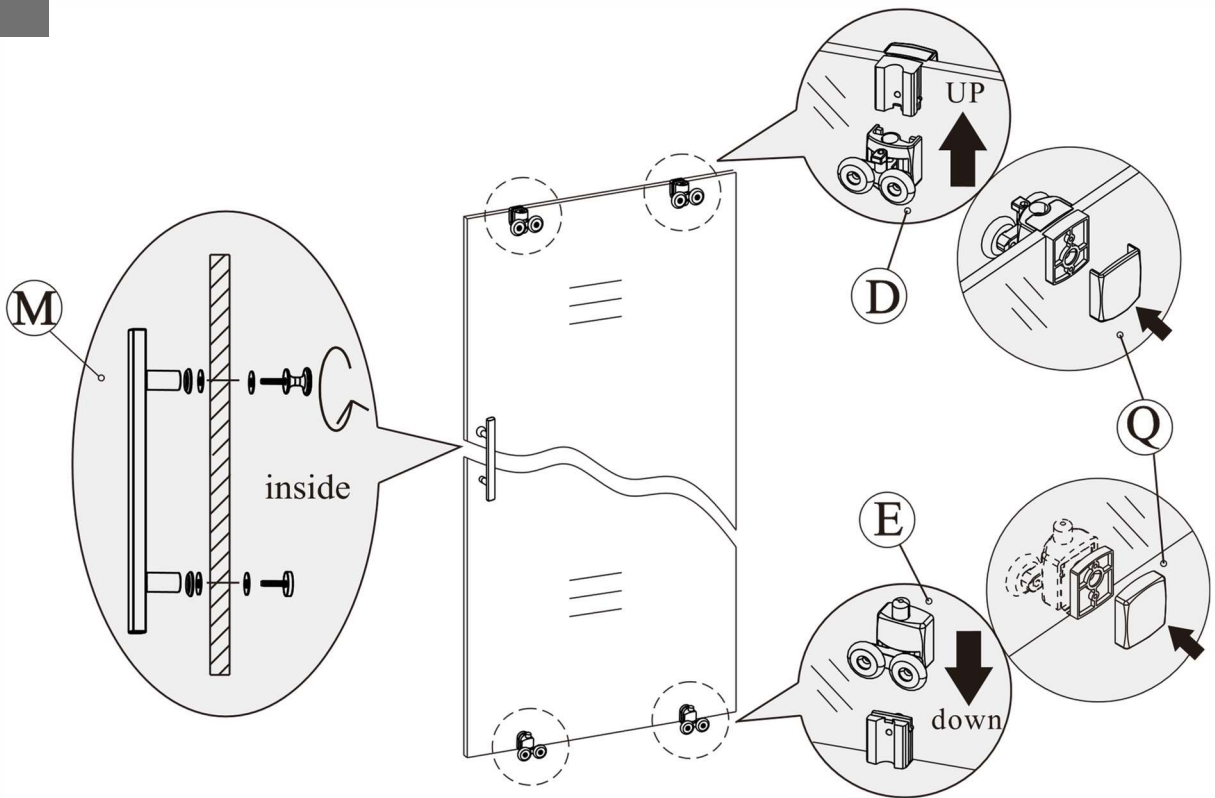

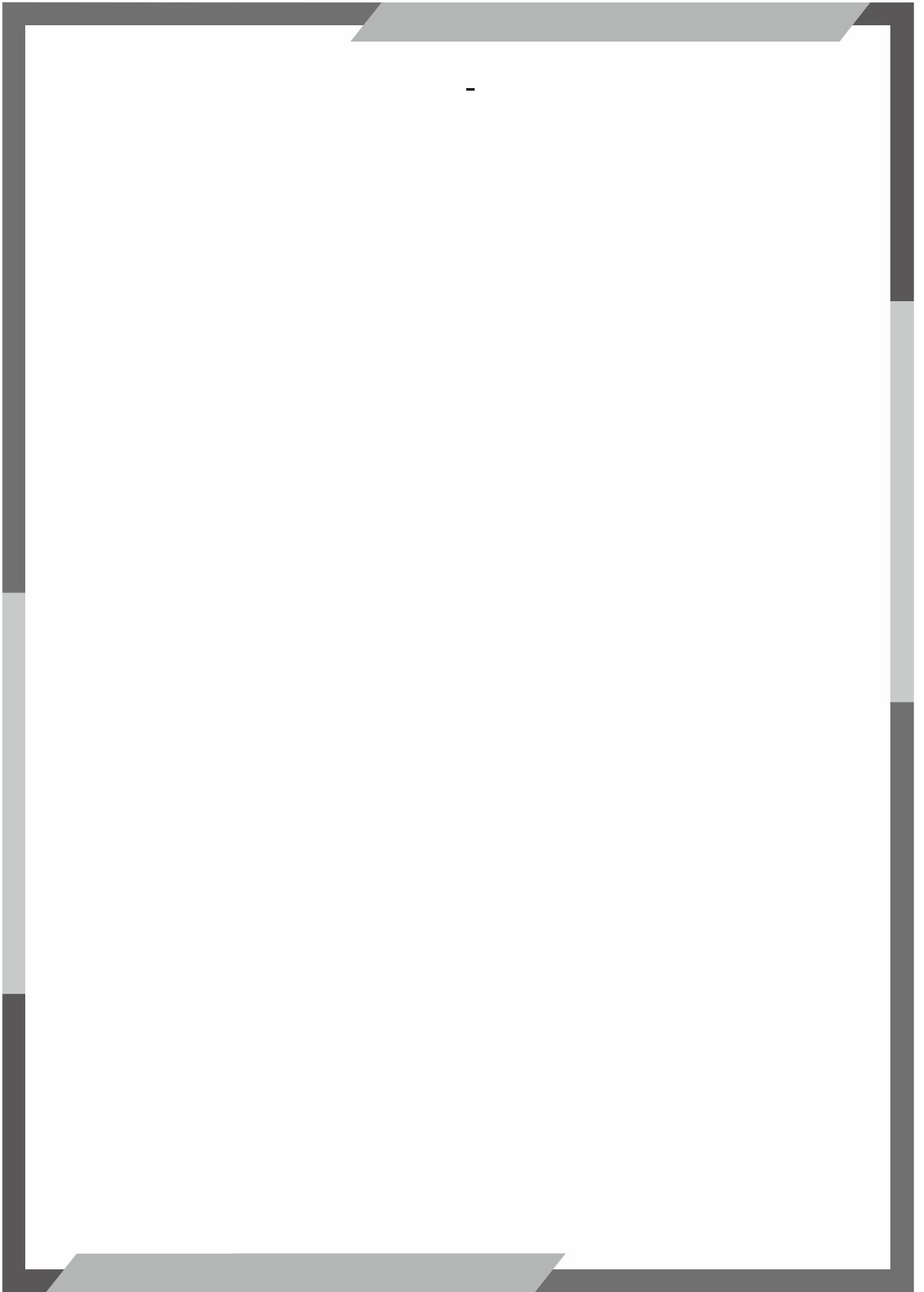

10

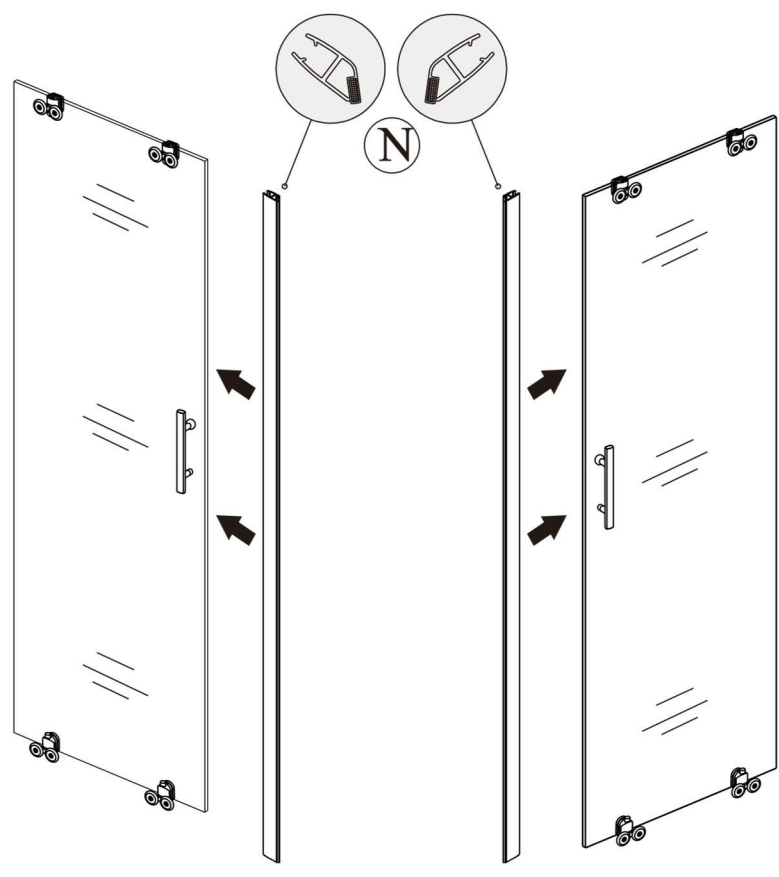

11

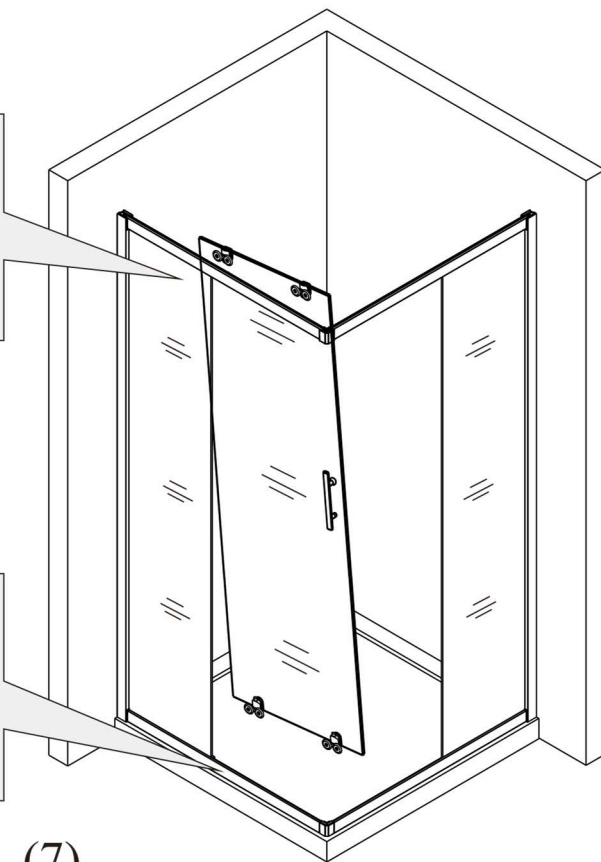
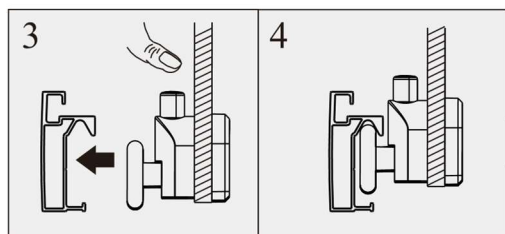
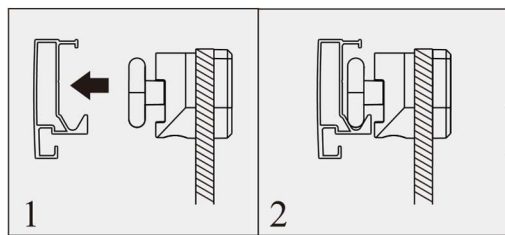

12

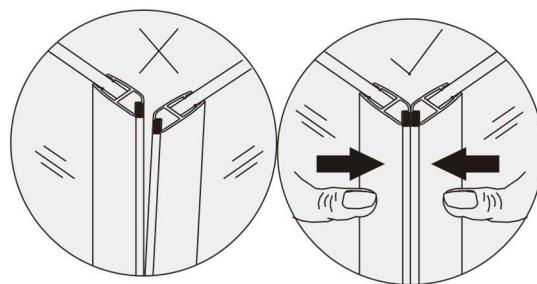
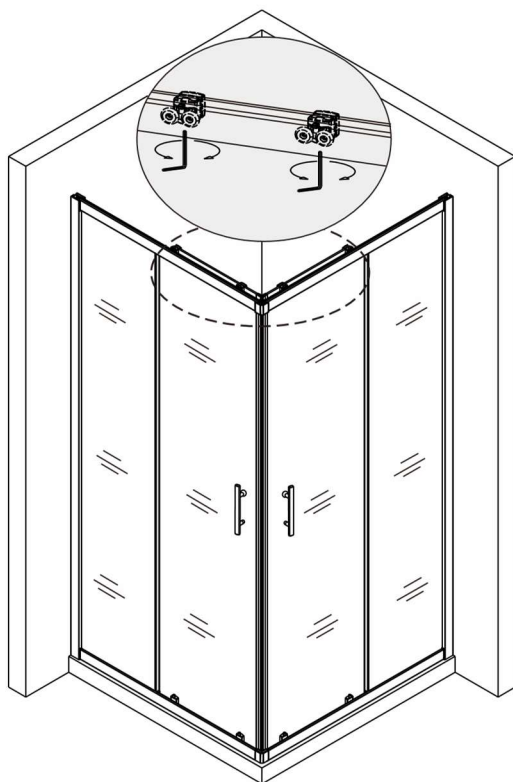

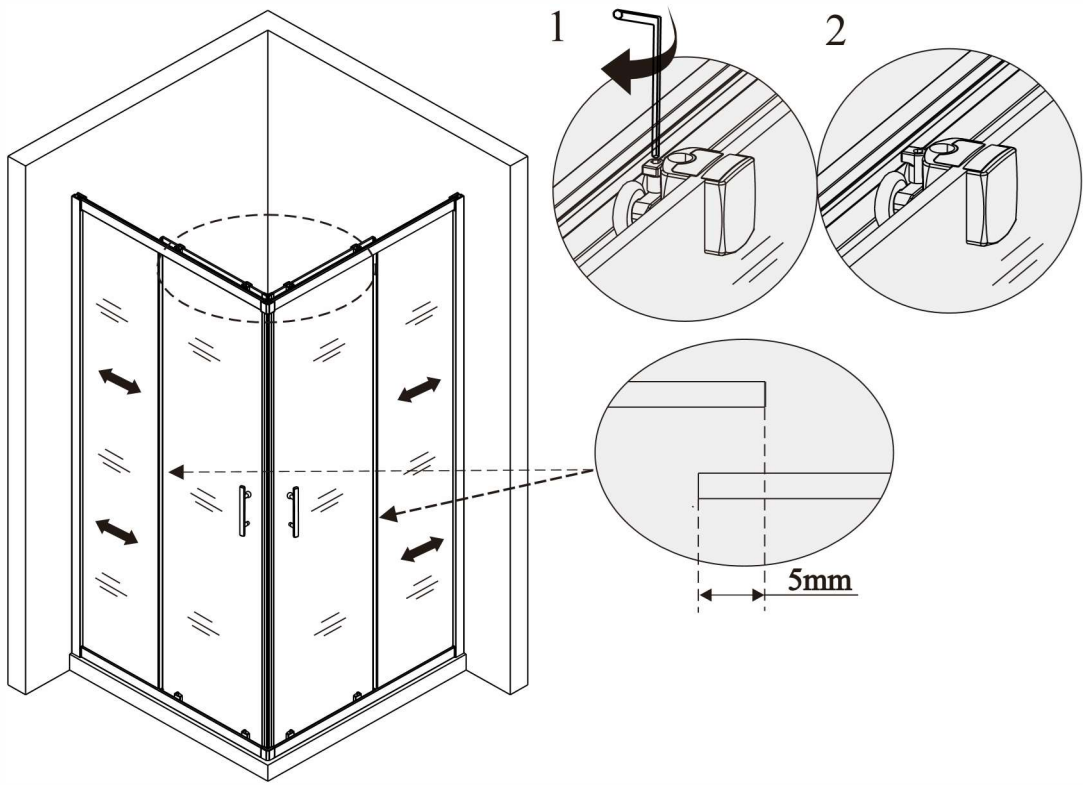

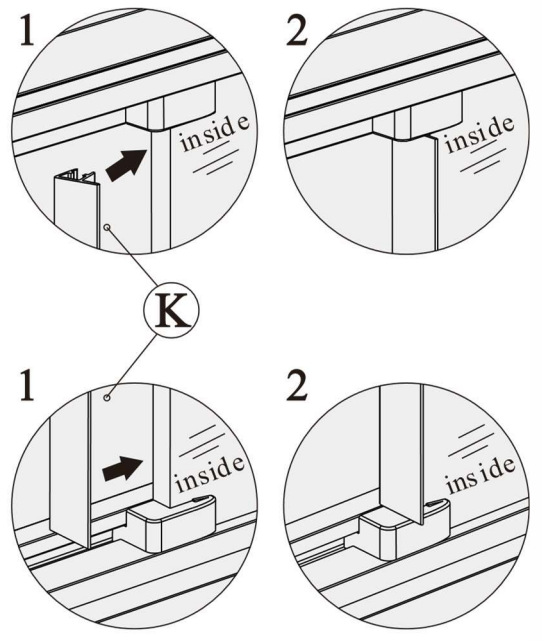
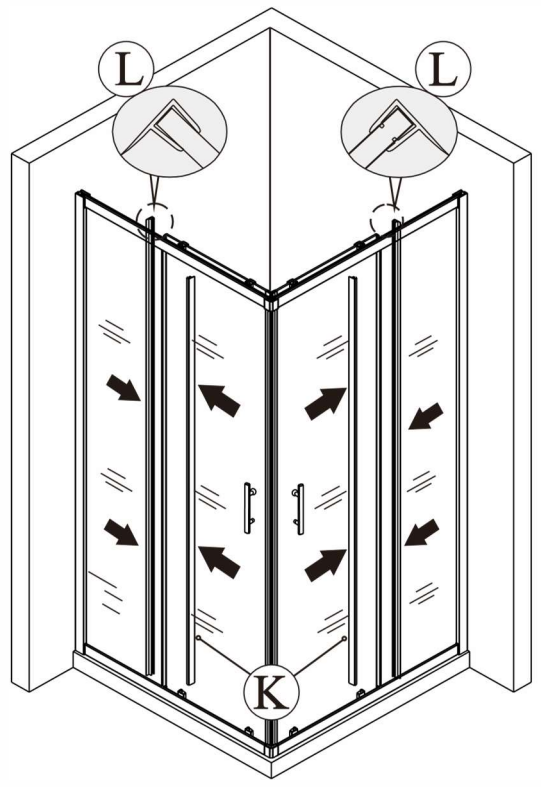
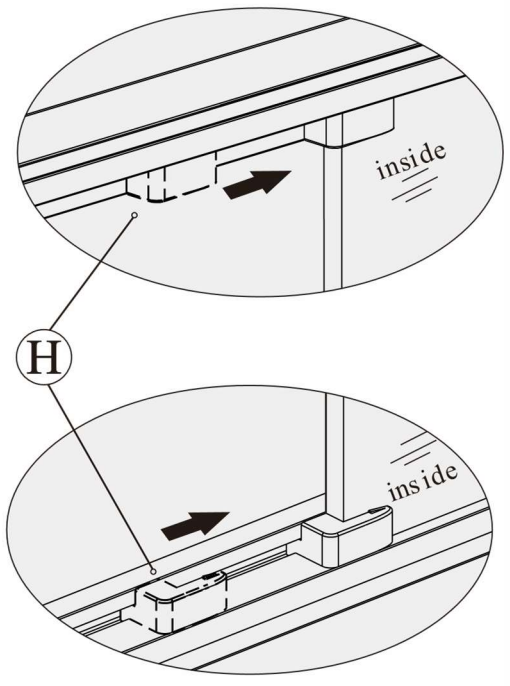
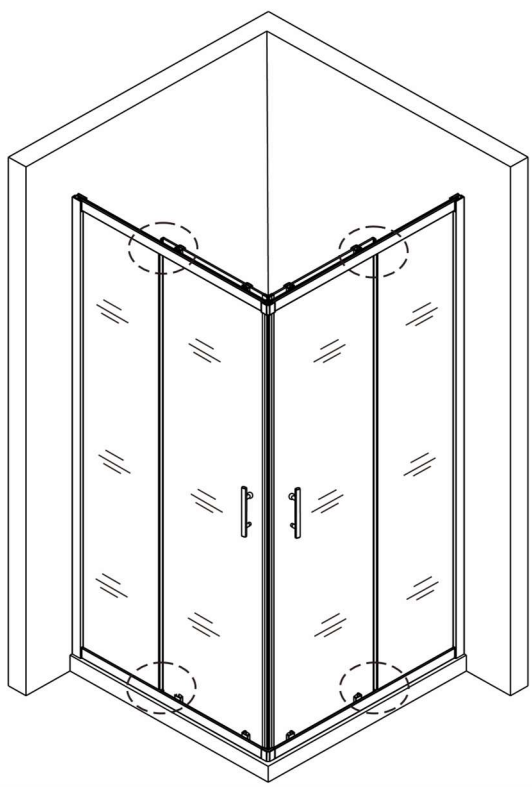

16

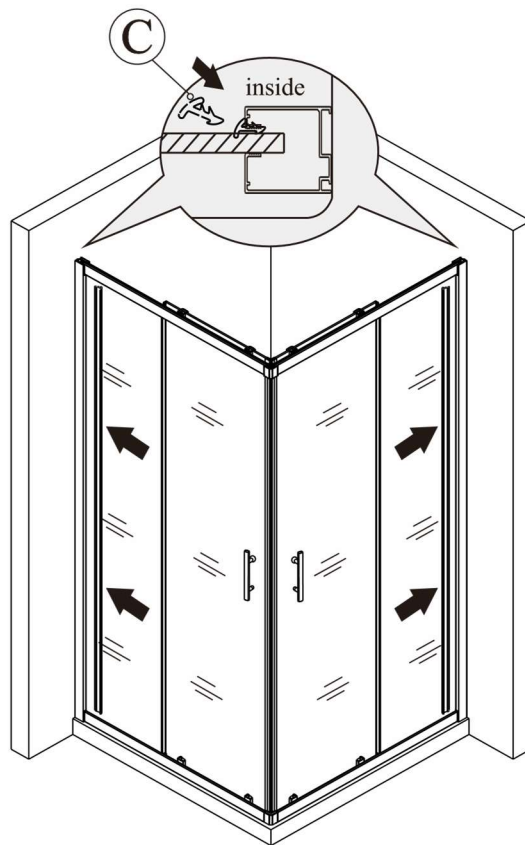

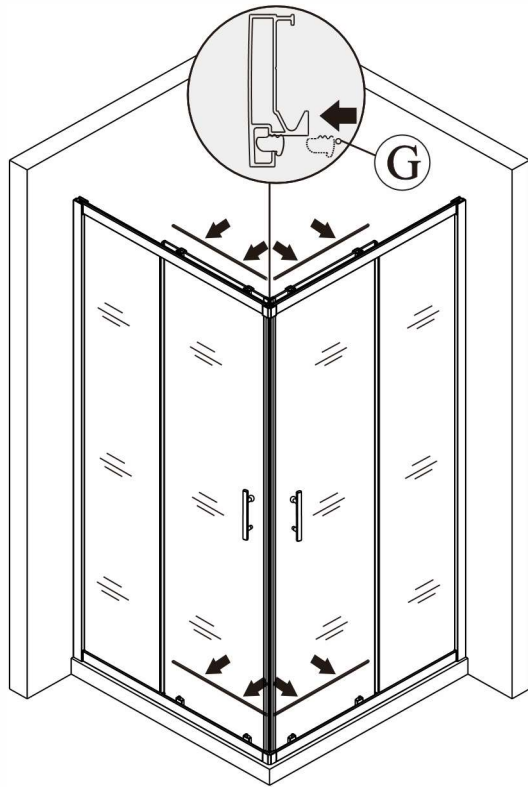

0

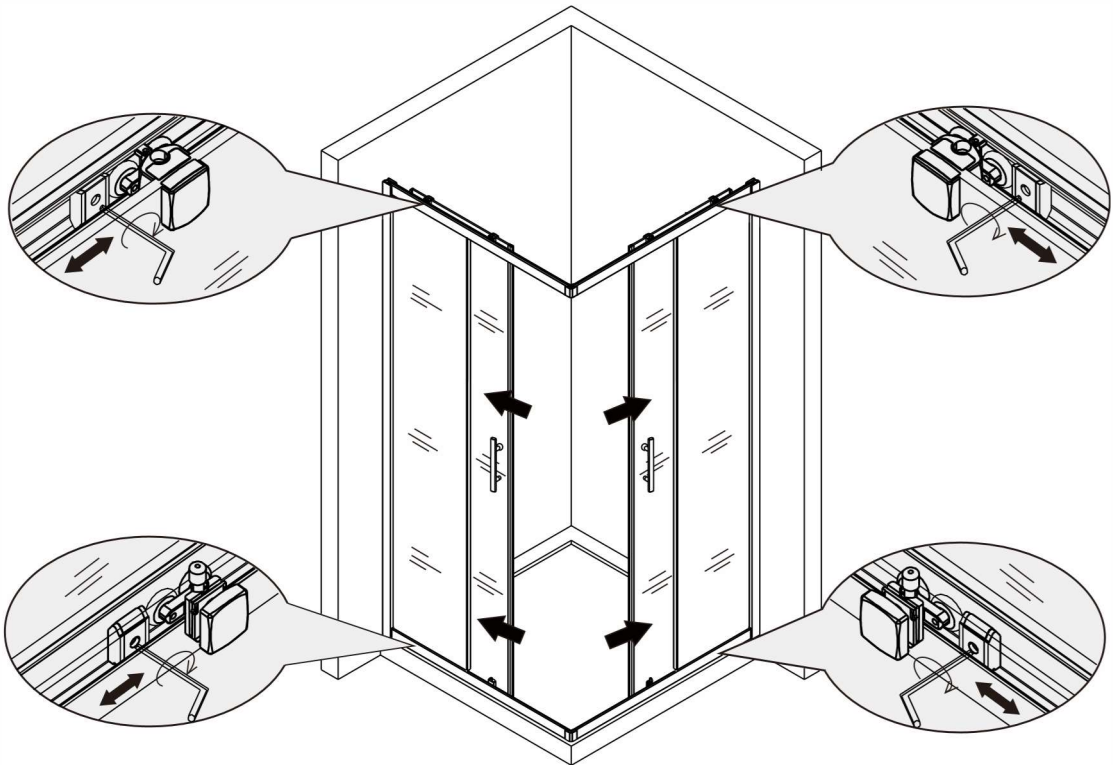

19

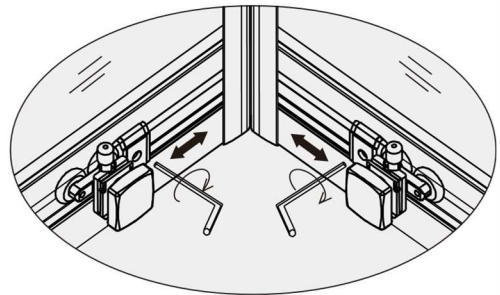
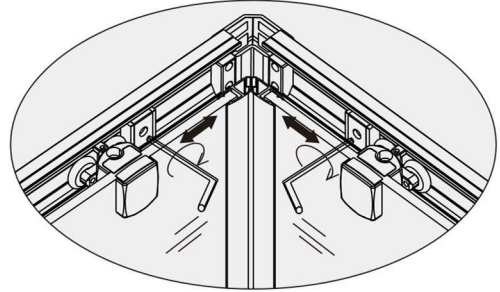
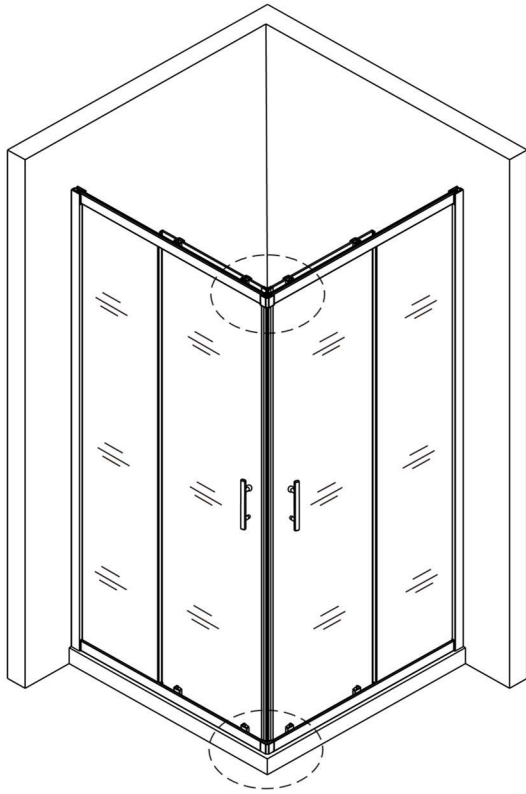

20

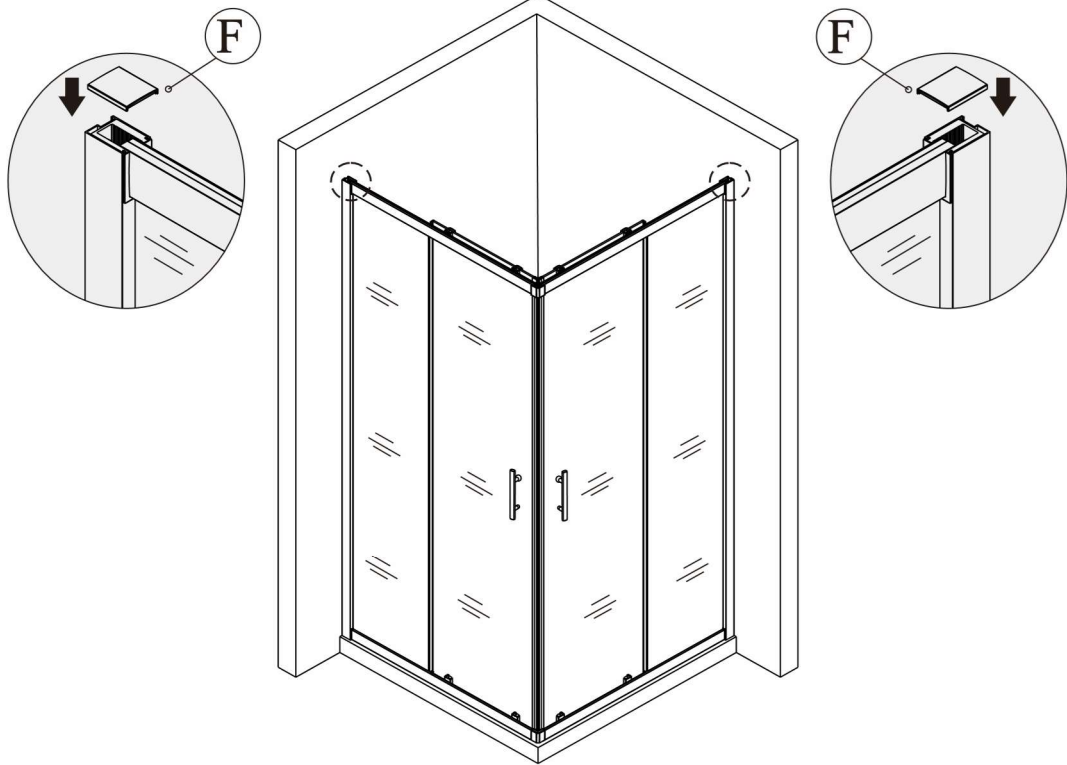

21

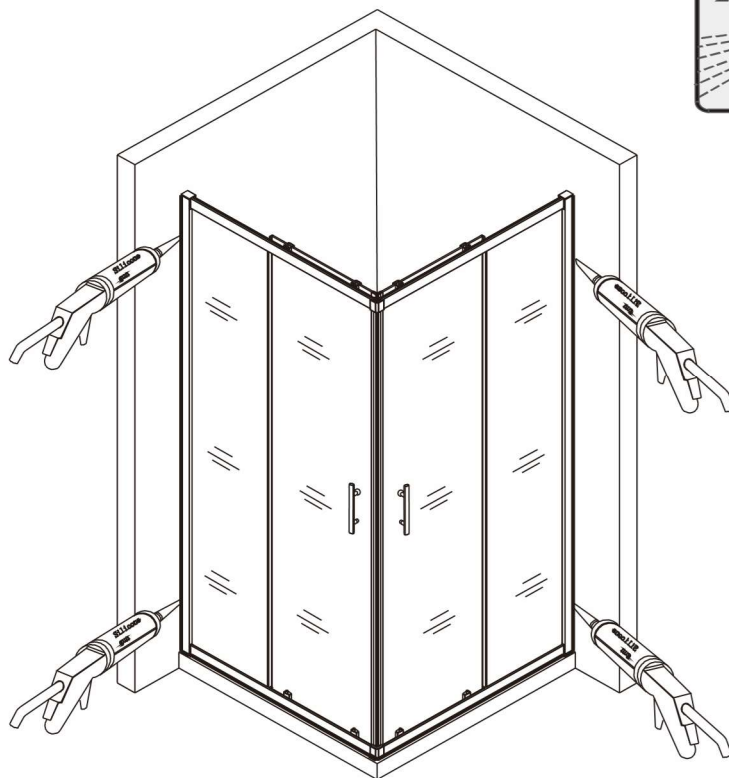

Apply some silicone on the outside edge of the shower enclosure (between the wall profiles and wall and between the frame and the tray) to enhance waterproof. After installation, it needs 24hours for silicone to dry before being put into use.

Cleaning & maintenance

Clean the sundries regularly to prevent the drain from being jammed. Usually, clean the shower enclosure by mop with mild detergent.

Don't clean the shower enclosure with irritant detergent, such as alcohol, gasoline or other chemical cleaner.

Should there be any dirty stains on the shower enclosure, you may clean it by calico with toothpaste, but you need to clean it with water afterwards.

After the installation is completed, if you find there is much noise when the glass door moves, you may add small quantity of lubricant onto the roller wheel, slipping hook and the track.

